

SPRING 2009

Using PBL to deliver course in Digital Electronics

ARCHANA MANTRI

Chitkara Institute of Engineering and Technology
Patiala, Punjab, India

DR. SUNIL DUTT

National Institute of Technical Teachers Training Institute
Chandigarh, India

DR. J.P. GUPTA

Jaypee Institute of Information Technology University
Noida, Uttar Pradesh, India

DR. MADHU CHITKARA

Chitkara Institute of Engineering and Technology
Patiala, Punjab, India

ABSTRACT

Problem Based Learning (PBL) has proven to be a highly successful pedagogical model in many educational fields, although it is comparatively uncommon in technical education. It goes beyond the typical teaching methodology by promoting student interaction. This paper presents a PBL trial applied to an undergraduate Digital Electronics course in the Electronics and Communication Engineering (ECE) program at Chitkara Institute of Engineering and Technology, affiliated with Punjab Technical University (PTU), India. Also included in this paper is the approach to design quasi—open—ended problems for the PBL trial in the basic Digital Electronics course and its delivery. It also includes the comparison of the results for the PBL and traditional pedagogies.

I. INTRODUCTION

Chitkara Institute of Engineering and Technology (CIET) is affiliated with Punjab Technical University (PTU), Jalandhar, India. The Board of Studies (BoS)—a high level committee of academicians at the university devises and decides the study scheme (curriculum), syllabi and the broad evaluation strategy for the Undergraduate program in ECE. A look at the scheme of this engineering program at the official website of PTU shows that the approach is very traditional, with a careful listing of objectives and aims of each course in the curriculum for the lecture/ tutorial and practical hours. It also enlists and details the broad evaluation strategy of the ECE program. In such an environment

Using PBL to deliver course in Digital Electronics

where the only method to impart technical education is traditional—Lecture, Tutorial and Practical (L/T/P) and where the affiliating university describes the approach to delivery, it is almost impossible to introduce any other pedagogy, without proving the usefulness of the new approach. In an effort to facilitate the paradigm shift, the authors initiated a series of efforts, to introduce PBL for the courses in undergraduate program of Electronics and Communication Engineering (ECE), at CIET.

The first of these efforts was in the course in Analog Electronics. Encouraged by the success of this trial, the results achieved [1, 2], and by the success of PBL in other similar courses elsewhere in the world [3–5], another PBL course was designed and delivered for the course of Digital Electronics (DE). This paper describes the syllabus of the Digital Electronics courses, lists the examples of the quasi-open-ended problems designed for the course, delivery of the course, the comparison of results of both of the pedagogies and the feedback, given by the students in support of PBL.

II. SYLLABUS OF DIGITAL ELECTRONICS

As prescribed by the affiliating University—the syllabus of Digital Electronics (DE) in the undergraduate program of Electronics and Communication Engineering covers the following topics:

- a. Number System and Binary Code
- b. Minimization of logic function
- c. Combinational Logic Circuits
- d. Sequential Circuits
- e. D/A and A/D Converters
- f. Semiconductor Memories
- g. Logic Families.

III. FORMATION OF THE TWO THREADS

In order to contrast the pedagogies and results, the class of second year ECE (69 students) was divided into two threads—The PBL thread and the Traditional thread.

(a) The formation of the Traditional thread was quite traditional with the students sitting in the classroom in rows, facing the teacher. The demarcation of Lecture, Tutorial and Practical classes was quite clear. The teacher gave lecture in lecture classes, made the students practice closed ended problems in tutorial classes and made the students do experiments in the practical classes, in a typical laboratory set up.

Using PBL to deliver course in Digital Electronics

(b) The students in PBL thread were first asked to form their groups with a minimum four and maximum five students in each group. The class had circular tables, with chairs around them and a scribble board placed in the centre. The set-up thus facilitated interaction and discussion among groups [16, 17]. A small library was also built in the classroom. The students were free to use the Internet on their laptops and search for any data and information required. They could use simulation software and laboratory equipment in the class itself for achieving any practical learning objectives.

(c) The experiment was first conducted with the lead author herself as the facilitator. The same experiment was repeated the next year with a fresh batch of 68 students, with the same set of Technical Problems (TPs) but with a different senior teacher as facilitator.

IV. TEACHING PEDAGOGY

(a) The teaching pedagogy for the Traditional thread continued to be “traditional” using Lecture, Tutorial and Practical classes, with the teacher as “Sage on Stage” [6]. The teacher made the Lecture plan and Lab Plan—an hour wise, lecture wise, lab wise schedule, for delivery of the whole syllabus, right from knowledge level to the application level. She also delivered the course in accordance to the same. The quasi-open-ended-problems, as given in section VI, were changed into more closed-ended-ones and given to the traditional group for practice, in the tutorial classes. These problems were in addition to many other analytical questions, which the students practiced in tutorial classes. The lecture and tutorial sessions were interlaced throughout the semester. The content delivery in the Lecture classes was one way—from teacher to students. However the students were allowed to work in groups, practice analytical problems and discuss the issues in Tutorial classes. The practice session for a particular topic was always after the concept was delivered and understood by the students in the Lecture classes. The practical sessions in the Lab classes had objectives, again, determined by the prescribed study scheme and syllabus of the affiliating University and the teacher. All in all, there was a clear demarcation in the Lecture, Tutorial and Lab classes in terms of the delivery of content, what the students performed and the Learning Objectives.

(b) For the PBL thread, there was no structured plan in terms of delivery of content. However the teacher—here, termed Facilitator - prepared a complete set of Technical Nodes and Learning Objectives. A few examples of Technical Nodes and Learning Objectives, related to the subject are:

Technical Nodes:

- Prepare truth table of a Demultiplexer and Multiplexer.
- Interpret the truth table of a Multiplexer and write the algebraic equation representing this combinational circuit.

Learning Objectives:

- Students should be able to recognize the circuit of a Demultiplexer and prepare its truth table.
- Should be able to use Decoder as Demultiplexer and vice versa.
- Should be able to wire the circuit of a Demultiplexer and a Multiplexer and use it as a complete set.

The facilitator designed open—ended Technical Problems (TPs) and got them authenticated by a group of senior teachers. While designing TPs, care was taken that the scope was broad enough so that the students could achieve all the Technical Nodes and Learning Objectives in the conceptual, while attempting to solve them.

Students grappled with these fuzzy Technical Problems—one at a time, as given in the section VI below and tried to understand the scope, issues and concepts stemming from or inherent in the TP before attempting to identify the learning points that would guide them towards the formulation of an eventual response [8] (in the form of a theory, hypothesis, solution or argument).

There was no demarcation of Lecture, Tutorial or Practical classes and the total time available for the course was divided into several two hour PBL-sessions. The students developed an understanding and also found the solution to the TP while traversing the conceptual space, covering the technical nodes and also learned to work in teams. The role of the teacher was changed from the “content-delivery-man” to a facilitator. The students worked on their Technical Problems, trying to find out one of the many possible solutions, determining and achieving their own theoretical and practical Learning Objectives. The teacher remained and worked as “guide-by-side,” truly taking up the role of a facilitator. She carefully monitored each and every step of the groups and remained aware of the progress made by the groups. At times, when the facilitator felt that all the students encountered the same kind of bottleneck, the facilitator either delivered a structured lecture or called upon all the students to perform the same experiment, so that they could proceed further. Moodle™ software was used for online submission of assignments and presentations for both the threads and also to extend the discussion among students even beyond the classroom.

V. TIME ALLOTMENT AND EVALUATION PARAMETERS

The total hours per week, allotted to the subject of Digital Electronics (DE), were fixed and was predecided by the university, the time allotments for the PBL thread and the Traditional thread were made parallel as given in Table 1. In the PBL sessions, the demarcation of lecture, tutorial and practical was removed and the students not only decided their strategy, but also managed their time to achieve their theoretical and practical Learning Objectives.

Using PBL to deliver course in Digital Electronics

Traditional thread	PBL thread
4 lecture hours per week	2 hour PBL class * 4 classes per week
2 tutorial hours per week	week
2 practical hours per week	
Total = 8 hours per week	Total = 8 hours per week

Table 1. Time Allotment for PBL and Traditional threads.

Internal Evaluation = 70 As done by the affiliated college (CIET, in this case)		External Evaluation = 80 As done by the University (PTU, in this case)
Traditional thread	PBL thread	Same for both PBL and Traditional threads
Attendance in Lecture and Tutorial classes (6)	One-to-one oral examination on the solution of the problem submitted: can be taken any time during the class. (6)*	Written Theory Paper (60) (Set by the University)
Assignments (10)	Assignments (10)**	Practical Performance and Viva Voce Examination (20) (Taken by an Examiner appointed by the University)
Mid semester tests (24)	Mid semester test (24)**	
Attendance in Labs (5)	Peer evaluation (-5 to +2)**	
Lab/file work (15)	Practical Work Done by the group (10)*	
Internal viva voce (10)	Presentation by the group (5)** Solution to the problem (10)* Attendance (5)	
*Weekly	** Thrice in a semester	

Table 2. Evaluation Parameters of Traditional and PBL Groups.

The selection of students for the PBL thread was truly random. Since the PBL class could not support a large size, the number was limited to 25. However, after the initial intake, some students left the class and rejoined the traditional group and the PBL thread was run with 18 students in the first experiment and with 21 students in the next batch.

The evaluation criteria of both the threads were matched as given in Table 2:

The external theory paper is set by the University and is a combination of subjective and objective type questions. The questions are incorporated, such that all the levels of Bloom's Taxonomy are tested in the paper.

Once the teaching pedagogy and time distribution were paralleled for both the threads, the course was delivered to both the groups, by the same teacher.

VI. THE TECHNICAL PROBLEMS (TP) DESIGNED FOR PBL THREAD

The Quasi-open-ended Technical Problems (TPs) in the PBL thread were the starting points of the delivery of the course and hence knowledge construction. These TPs were carefully framed in discussion with senior teachers of the department. When citing instances for evaluation for PBL, it is found that usually, the evaluation strategy for PBL is quite different from that of the traditional practices. But in this case, since the outer framework of evaluation was that of the University and could not be changed, the Technical Problems framed in this environment, could not be truly open-ended. However, they were broad enough so as to induce thinking in the students' minds and while attempting the TPs, they were able to traverse and cover the relevant portions of the syllabus. Some Technical Problems from the whole set are listed below:

TP 1:

An electronic telephone exchange is being powered by a normal power supply. However, looking at the criticality of the exchange, a power backup generator is also installed, which can supply power in case of power failure. An alarm circuit is to be designed. There will be two LEDs (one green and the other red) on the front panel of the exchange, such that the green LED glows when power supply is available. In case of failure of power supply, the exchange draws its power from a generator, and in this case, the green LED goes OFF and the RED LED glows. In case, the generator also goes down, both green LED and red LED go OFF and a buzzer starts ringing indicating that there is a major failure. Design this control circuit for both the LEDs and the buzzer.

- Define independent and dependant variables in (a), (b) and (c) above.
- Develop a mathematical expression for above sets of statements.
- Tabulate the above sets of statements symbolically by using variables defined above, wherever required.
- Show the above sets of statements pictorially.
- Verify your results practically.

Using PBL to deliver course in Digital Electronics

TP 2:

The arithmetic and Logic Unit of a computer performs the arithmetic and logic operations for the processor. In this ALU a circuit is to be designed, where in two 4-bit binary numbers are to be subtracted using two's complement. Design a combinational circuit for the same.

TP 3:

You are reporting for duty in your first ever assignment as graduate trainee in the design department of an electronics firm. The following problem has been given to you:

A portion of the transceiver electronics of the exchange is depicted in the form of block diagram as given in Figure 1.

Both the exchanges cater for 2^n users. Depending on n selection lines you have to design and test the multiplexer and demultiplexer circuits in the exchange. You have to find out the commercially available ICs from at least three vendors and prepare a BOM (Bill of Material). Your boss has given you a time limit of four hours to design the same and submit the solution in written form.

The data available from users are in analog form.

TP 4:

(A) In a computer, the central processing unit (CPU) works as the brain. It not only does the calculations and logical operations but also takes care of input and output operations. In such a generalized operation, there are eight devices that this processor is handling. The tabulation is given below in Table 3:

The processor has a 6-bit address bus. Devise out a method to generate the port number of each I/O devices one at a time, and send/receive the data.

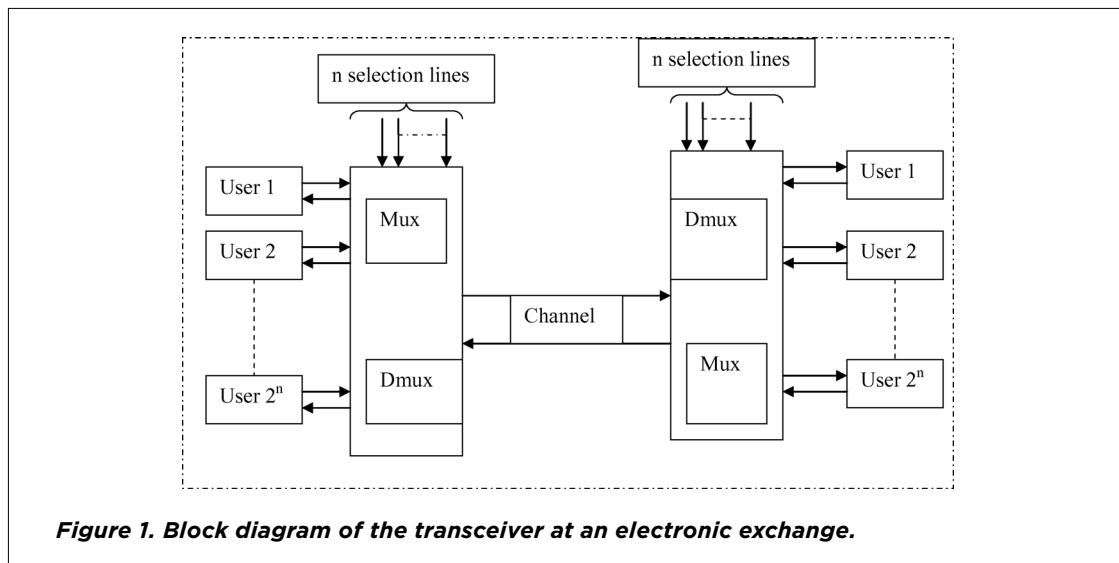

Figure 1. Block diagram of the transceiver at an electronic exchange.

Port number	Device
0	Printer
1	Scanner
2	Fax machine
3	Key board
4	Mouse
5	Speaker
6	Mike
7	Monitor

Table 3. Devices to be connected to the CPU and the port numbers.

(B) Before transmitting analog data using digital bus, the same is converted into digital bits and encoded too. For coding the data, many coding schemes exist. One of the error detecting codes is an even parity code, which you have studied earlier. At the receiver, digital bit streams are being received. They are first passed through an 8-bit serial to parallel converter. Before feeding them to subsequent processing circuit, the parity is to be checked in an error detector. Design the detector to perform the described operation.

VII. FACILITATING THE PBL THREAD, CONTRAST OF RESULTS

Twenty-one students, who enrolled for the PBL thread, were asked to frame their groups. They were given introductory presentations on collaborative learning, in order to prepare them for the new learning experience. Technical-Problem I was given as the starting point of the PBL class. The teams were then asked to frame the Learning Objectives on their own. The students could decide only some of the Learning Objectives very vaguely (they were never aware of all the issues involved in solving a problem) [7]. The facilitator, then, supplemented their Learning Objectives by adding the remaining ones, so as to make it a complete set. Having a complete set of Learning Objectives was a very important step to determine the direction of work. These Learning Objectives, in turn, were important driving forces and acted as triggers towards the desired outcome(s), while working towards the solution. At times, the Learning Objectives got added in due course, while the search for information was still ongoing. The group members then distributed various tasks among themselves; e.g., search for information from various resources, compile the data, do calculations, perform experiments and finally write up the work done and prepare presentation. The group members were encouraged to rotate the above tasks among themselves for each Technical Problem at hand. For each Technical Problem, the group members were asked to elect a team leader, who would streamline things and make necessary decisions on work distribution. The group members were also encouraged

Using PBL to deliver course in Digital Electronics

to discuss the issues, decide their own theoretical, practical and software aims and explore through their own learning and mistakes. This was done by continuous monitoring and instructing them to record each relevant finding, any mistakes committed and the corrective action taken. Once they had reached the solution, they were also asked to frame similar kind of problems and identify application areas. All in all, they were guided and corrected by the wandering facilitator who would optimize the time and learning and also helped them to draw conclusions so as to find the desired solution. Learning took place as the students encountered successes and failures while exploring. The facilitator emphasized on this “exploration” voyage as much as reaching the correct solution.

The Descriptive and the ANOVA tables are shown in Tables 4-7. Tables 4 and 5 show more specifically the first experiment when the author herself was the facilitator. Tables 6 and 7 show the same results with total number of students as 131 and has the Descriptives and ANOVA values for both batches taken together. The p-values are close to 0 in all the cases (Tables 5 and 7). The higher values of Mean in PBL groups and smaller values of Standard deviations, except in case of ‘knowledge_test_score_external’ (Tables 4 and 6), are indicative of the better results obtained in case of PBL threads as compared to those in Traditional Threads. The six outliers in the data, which pertain to students who failed in their total_knowledge_test_score, have been excluded from the analysis.

		N	Mean	Std. Deviation	Std. Error	95% Confidence Interval for Mean		Minimum	Maximum
						Lower Bound	Upper Bound		
Knowledge_Test_Score_Internal	PBL	18	29.94	4.249	1.002	27.83	32.06	20	35
	Traditional	51	24.37	7.748	1.085	22.19	26.55	4	38
	Total	69	25.83	7.398	.891	24.05	27.60	4	38
Knowledge_Test_Score_External	PBL	18	29.50	13.268	3.127	22.90	36.10	9	58
	Traditional	51	22.63	8.012	1.122	20.37	24.88	4	42
	Total	69	24.42	10.023	1.207	22.01	26.83	4	58
Total_Knowledge_Score	PBL	18	59.44	13.281	3.130	52.84	66.05	29	86
	Traditional	51	47.00	13.526	1.894	43.20	50.80	19	77
	Total	69	50.25	14.454	1.740	46.77	53.72	19	86
Total_Skill_Score	PBL	18	41.17	3.552	.83	39.40	42.93	33	46
	Traditional	51	38.20	3.020	.423	37.35	39.05	32	45
	Total	69	38.97	3.404	.410	38.15	39.79	32	46

Table 4. Descriptive of PBL and Traditional group for their Knowledge and Skill Scores.

Using PBL to deliver course in Digital Electronics

		Sum of Squares	df	Mean Square	F	Sig.
Knowledge_Test_Score_ Internal	Between Groups	413.047	1	413.047	8.364	.005
	Within Groups	3308.866	67	49.386		
	Total	3721.913	68			
Knowledge_Test_Score_ External	Between Groups	628.390	1	628.390	6.788	.011
	Within Groups	6202.422	67	92.573		
	Total	6830.812	68			
Total_Knowledge_Score	Between Groups	2060.367	1	2060.367	11.365	.001
	Within Groups	12146.444	67	181.290		
	Total	14206.812	68			
Total_Skill_Score	Between Groups	117.403	1	117.403	11.731	.001
	Within Groups	670.539	67	10.008		
	Total	787.942	68			

Table 5. ANOVA table showing p-values of various types of evaluation.

		N	Mean	Std. Deviation	Std. Error	95% Confidence Interval for Mean		Minimum	Maximum
						Lower Bound	Upper Bound		
Knowledge_Test_Score_Internal	PBL	39	31.51	4.662	.746	30.00	33.02	20	39
	Traditional	92	24.66	6.868	.716	23.24	26.09	4	38
	Total	131	26.70	7.018	.613	25.49	27.92	4	39
Knowledge_Test_Score_External	PBL	39	29.41	9.405	1.506	26.36	32.46	9	58
	Traditional	92	22.86	6.460	.673	21.52	24.20	4	42
	Total	131	24.81	8.007	.700	23.43	26.19	4	58
Total_Knowledge_Score	PBL	39	60.92	10.074	1.613	57.66	64.19	29	86
	Traditional	92	47.52	11.361	1.184	45.17	49.87	19	77
	Total	131	51.51	12.564	1.098	49.34	53.68	19	86
Total_Skill_Score	PBL	39	40.95	3.839	.615	39.70	42.19	33	47
	Traditional	92	36.46	4.503	.469	35.52	37.39	16	45
	Total	131	37.79	4.770	.417	36.97	38.62	16	47

Table 6. Descriptives of PBL and Traditional scores of both the sets, with different facilitators.

Using PBL to deliver course in Digital Electronics

		Sum of Squares	df	Mean Square	F	Sig.
Knowledge_Test_Score_Internal	Between Groups	1285.091	1	1285.091	32.389	.000
	Within Groups	5118.298	129	39.677		
	Total	6403.389	130			
Knowledge_Test_Score_External	Between Groups	1175.630	1	1175.630	21.185	.000
	Within Groups	7158.599	129	55.493		
	Total	8334.229	130			
Total_Knowledge_Score	Between Groups	4919.007	1	4919.007	40.672	.000
	Within Groups	15601.726	129	120.944		
	Total	20520.733	130			
Total_Skill_Score	Between Groups	552.712	1	552.712	29.650	.000
	Within Groups	2404.724	129	18.641		
	Total	2957.435	130			

Table 7. ANOVA table showing p-values for both the batches taken together.

In order to gauge the design and synthesis skills of the students, a small project was given to all the students in the class at the end of the term. The students were given two separate wired digital circuits on bread boards, with a single fault introduced in each circuit. The circuits given were Hexadecimal to Seven Segment decoder and a Three-bit Asynchronous Counter.

The assessment procedure of the skill test included drawing the circuit by tracing the connections, identify the circuit, making the truth table/state table, finding out the faults, rectifying them and making the circuits work. All of the components, taken together and the timely completion of the skill test were graded on a scale of A++ to D. While PBL students were allowed to work in their groups, the students of the Traditional thread were also asked to choose their teammates and make their groups. All of them were required to find a workable solution to the project in a span of four hours. A team of four senior faculty members was then asked to evaluate the projects on a predefined strategy. Results showed that four of the five groups from the PBL thread were graded A++, while one group was graded B+. On the contrary, only two groups of the Traditional thread could be graded A+, the rest were graded below B. This result was a clear indication of better skills acquired by the PBL students, both in terms of working in groups and in practical knowledge and ability.

A questionnaire, shown in Table 8, was circulated to all the students in the class; Table 8 also gives the summarized results.

S. No	On a scale of 1 to 10 the students answered the following questions: (1 for most negative response and 10 for most positive response)	Response: PBL thread (Mean, S.D.)	Response: Traditional thread (Mean S.D.)
1	What was your satisfaction level with the tutor of Digital Electronics?	(7.7, 1.9)	(7.7, 2.0)
2	How confident are you that you would be able to extrapolate the theoretical concepts and analytical skills learned in DE to other subjects in higher classes?	(6.4, 3.2)	(4.2, 2.8)
3	On an average how much time of the class did you use effectively?	(9.5, 2.1)	(5.4, 3.4)
4	Are you confident of performing well in the external exams?	(4.8, 3.5)	(5.2, 4.0)
5	Did you copy the assignments? (on a scale of 1 to 5)	(2.6, 2.1)	(3.3, 3.5)
6	Did you enjoy attending the classes of DE?	(9.4, 2.4)	(6.3, 3.4)
7	Rate your practical skills in DE (assembling the circuits, wiring, troubleshooting etc.).	(6.6, 2.0)	(4.9, 2.9)

Table 8. Questionnaire and the student responses.

VIII. CONCLUSION

Many instances of using PBL in nursing and medical stream are cited [12-15] in the literature, but one finds very few instances of using the PBL approach in the worldwide engineering curriculum literature [3-5, 9-11] and none in North India. Even the pedagogy of teaching and the evaluation is decided by the University. This leaves very little room to employ PBL in various courses. By taking up this series of efforts for various courses in the under graduate Electronics and Communication Engineering program, a unique way of integrating PBL with the evaluation strategy of University, has been initiated, implemented and evaluated.

Analysis of the knowledge test conducted on the students by way of end semester exams and internal written theory papers showed that the Class Mean was 64%. It also showed that while the PBL students scored much better in the internal component of the knowledge test, there was no major difference in the external component, with the scales slightly tilting in favor of the PBL students. However, a remarkable difference was noticed in the skill test and in response to the attitude survey questionnaire (Table 4). The practical skills acquired by the students of PBL thread were more than those acquired by the students in Traditional thread, as is clear from the result of the skill test

Using PBL to deliver course in Digital Electronics

conducted at the end of the semester. It was observed that the students voluntarily spent more time in the PBL class than their Traditional thread counterparts. This fact can have more than one inference. If taken in reference to the slightly better knowledge test scores, this can mean that the students in PBL had to spend more time in the class to have a better knowledge score. On the other hand more time spent in the PBL class can be attributed to greater motivational level of the students in PBL. The response to question 2 in Table 4 (Figure 2b) clearly shows a better understanding level for the PBL thread. The response to question 4 (Figure 2d) needed a little more questioning from the students as to why the PBL students were not as confident of performing well in the exams. However, no satisfactory explanation could be obtained from the students. If the responses to questions 3 (Figure 2c), question 6 (Figure 2f) and question 7 (Figure 2g) in Table 6, are any indication of the productivity in terms of Learning Objectives, the scale definitely tilts in favor of PBL. The copying habits

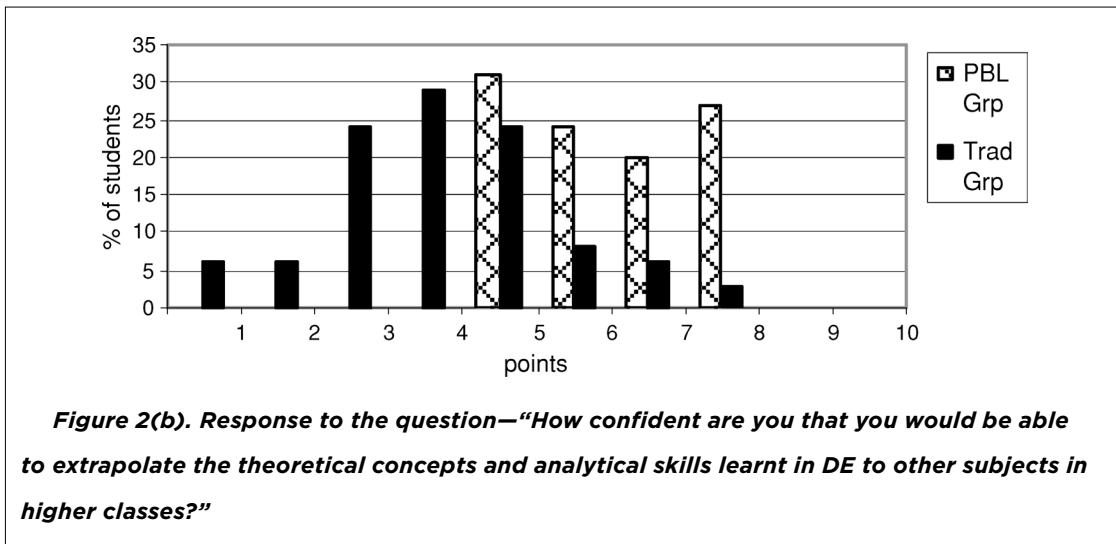
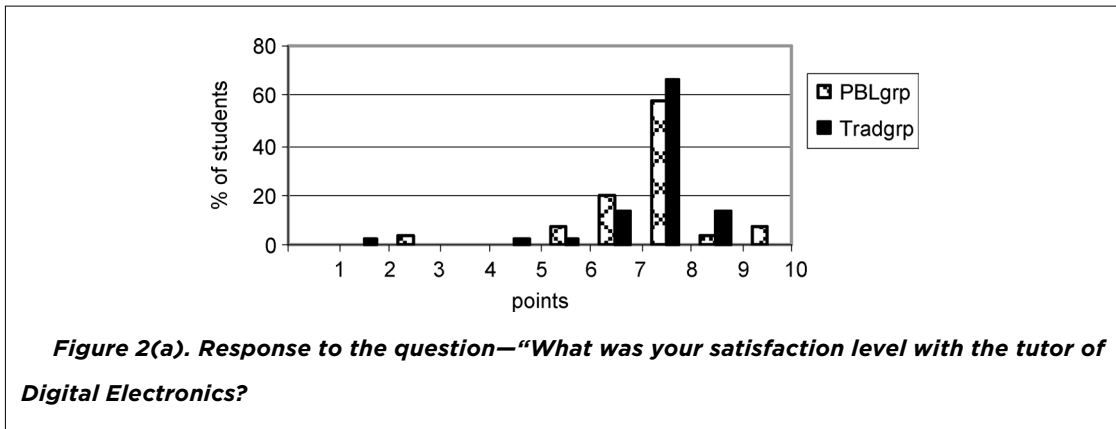

Using PBL to deliver course in Digital Electronics

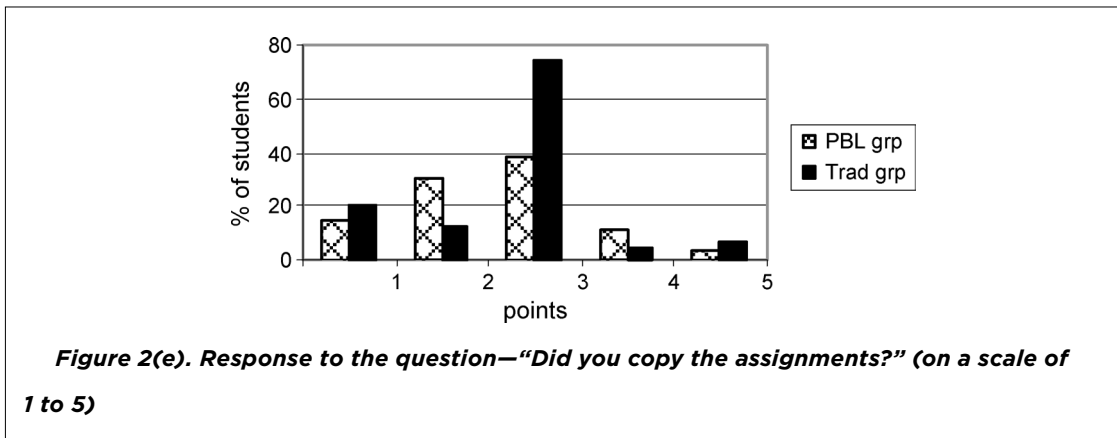
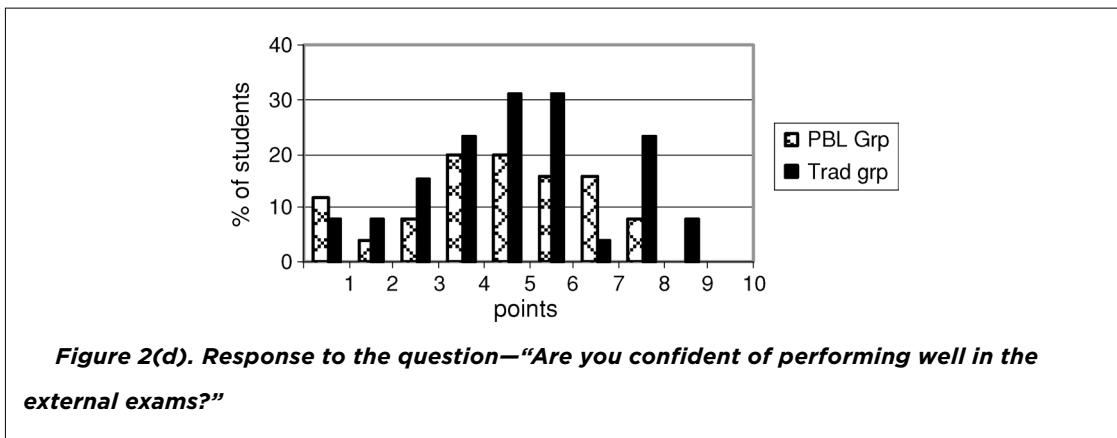
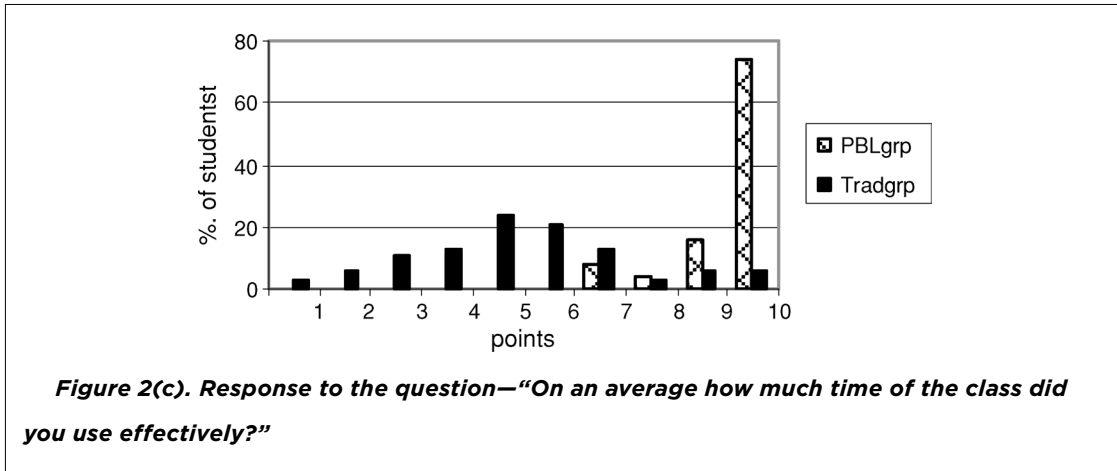

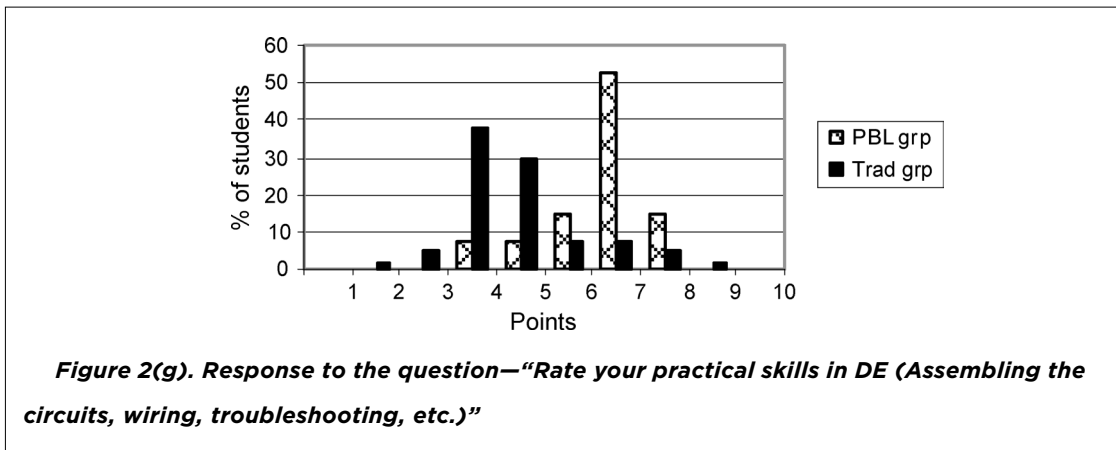
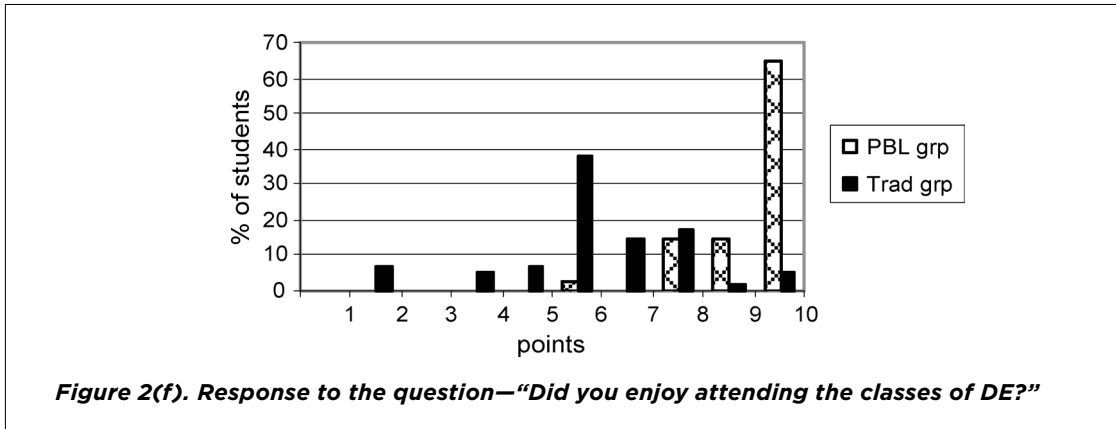

of the students for assignments, however, were comparable in both PBL and Traditional threads. All in all, with two experiments done—one in Analog Electronics [1] and the other in Digital Electronics, though the sample sizes were small, and with encouraging results obtained in both the experiments, it is recommended that PBL be used on wider basis. However before deciding to switch over from the traditional methodology to PBL, more issues like faculty training in handling PBL classes, and the cost factor, since the PBL class cannot handle large numbers, need to be sorted out first.

REFERENCES

[1] A. Mantri, S. Dutt, J.P. Gupta, and M. Chitkara, “Design and Evaluation of a PBL based Course in Analog Electronics,” IEEE Transactions on Education, vol. 51, no. 4, pp. 432-438, Nov 2008.

[2] A. Mantri, S. Dutt, J.P. Gupta, and M. Chitkara, “Designing problems for problem-based learning course in Analog Electronics: Cognitive and pedagogical issues,” Australasian Journal of Engineering Education, vol. 14, no. 2, pp. 33-42, 2008.

- [3] D.L. Maskell and P.J. Grabau, "A Multidisciplinary Cooperative Problem-Based Learning Approach to Embedded Systems Design," IEEE Transactions on Education, vol. 41, no. 2, May 1998.
- [4] A. Striegel and D.T. Rover, "Problem based learning in an introductory computer engineering course," 32nd frontier, ASEE/IEEE Frontiers in Education conference, Nov 6-9, 2002, <http://www.wpi.edu/News/Conf/FIE2002/>.
- [5] N. Linge and D. Parsons, "Problem-Based Learning as an Effective Tool for Teaching Computer Network Design," IEEE Transactions on Education, vol. 49, no. 1, Feb 2006.
- [6] C.M. Anson, L.E. Bernold, C. Crossland, J. Spurlin, M.A. McDermott, and S. Weiss, "Empowerment to Learn in Engineering: Preparation for an urgently needed paradigm shift," Global Journal of Engineering Education, vol. 7, no. 2, pp. 146, 2003.
- [7] D. Boud and G. Feletti, "The Challenge of Problem-Based Learning," 2nd ed., London, U.K.: Kogan, 1998.
- [8] B. Wilson and P. Cole, "Cognitive Teaching Models," in Handbook of Research in Instructional Technology, 1st ed., pp. 601-621, New York: Scholastic, 1996.
- [9] J.E. Greenberg, B. Delguite, and M.L. Gray, "Hands-on Learning in Biomedical Signal Processing," IEEE Engineering in Medicine and Biology Magazine, pp. 71-79, Jul-Aug, 2003.
- [10] R.M. Felder, "Teaching Engineering at a Research University: Problems and possibilities," Education Quimica, 15(1), pp. 40-42, 2004.
- [11] W.E. Mortiz and L.L. Huntsman, "A collaborative approach in biomedical engineering education," IEEE Tra. Biomed. Eng., vol. 22, pp. 124-129, 1975.
- [12] H.S. Barrows and R.M. Tamblyn, "Problem Based Learning: An approach to Medical Education," New York: Springer Publishing, 1980.
- [13] H.G. Schmidt, "Problem Based Learning: Rationale and description," Medical Education, vol. 23, pp. 542-558, 1987.
- [14] E. Rideout and B. Carpio, "The Problem based learning model of Nursing Education" in E. Rideout (Ed.), Transforming Nursing Education through PBL. Boston: Johns and Bartlett Publishers, 2001.
- [15] H.G. Schmidt, "Foundations of Problem based Learning: Some explanatory notes," Medical Education, vol. 27, pp. 422-432, 1993.
- [16] B.A. Oakley, D.M. Hanna, Z. Kuzmyn, and R.M. Felder, "Best Practices Involving Teamwork in the Classroom: Results from a Survey of 6435 Engineering Student Respondents," IEEE Transactions on Education, vol. 50, no. 3, pp. 266-272, Aug 2007.
- [17] R.M. Felder and R. Brent, "Effective strategies for cooperative learning," J. Coop. Collab. College Teach, vol. 10, pp. 69-75, 2001.

AUTHORS

Archana Mantri holds the M.Tech. degree (Digital Communication) from NIT, Bhopal, India. Presently working as Director Academics at Chitkara Institute of Engineering and Technology, she is pursuing her doctoral research in Electronics and Communication Engineering and Education Technology. Her areas of interest include Circuit Theory and Analysis, Digital Communication, and Education Technology.

Using PBL to deliver course in Digital Electronics

Sunil Dutt holds a Ph.D. in Education and has published many works in Psychology of Adult Learning and Performance Evaluation. His areas of specialization include Research Methodology, Measurement and Evaluation, and Educational Management.

J.P. Gupta is an alumnus of Banaras Hindu University. He is a postgraduate in Electronics and Communication Engineering and holds a Doctoral degree in Computer Engineering from the University of Westminster, London. Presently the Vice Chancellor of Jaypee Institute of Information Technology University, he is an acclaimed academician and an ex-professor of IIT, Roorkee. He has guided many Ph.D. theses and held important administrative positions in important government bodies, besides being involved in many research and developmental activities.

Madhu Chitkara holds a Doctorate in Education; her areas of interests are as varied as Education Technology, Pure Mathematics, Architecture, and Governance. Being instrumental in bringing revolutionary changes in the educational scenario of the region and recipient of “Rashtra Vikas Ratan Award,” by NEHEG, India, she is looked upon as the Education Icon in the region of Punjab, India. She is also the Director of Chitkara Educational Trust.